

Felix Pro 1 - Cover Assembly Manual

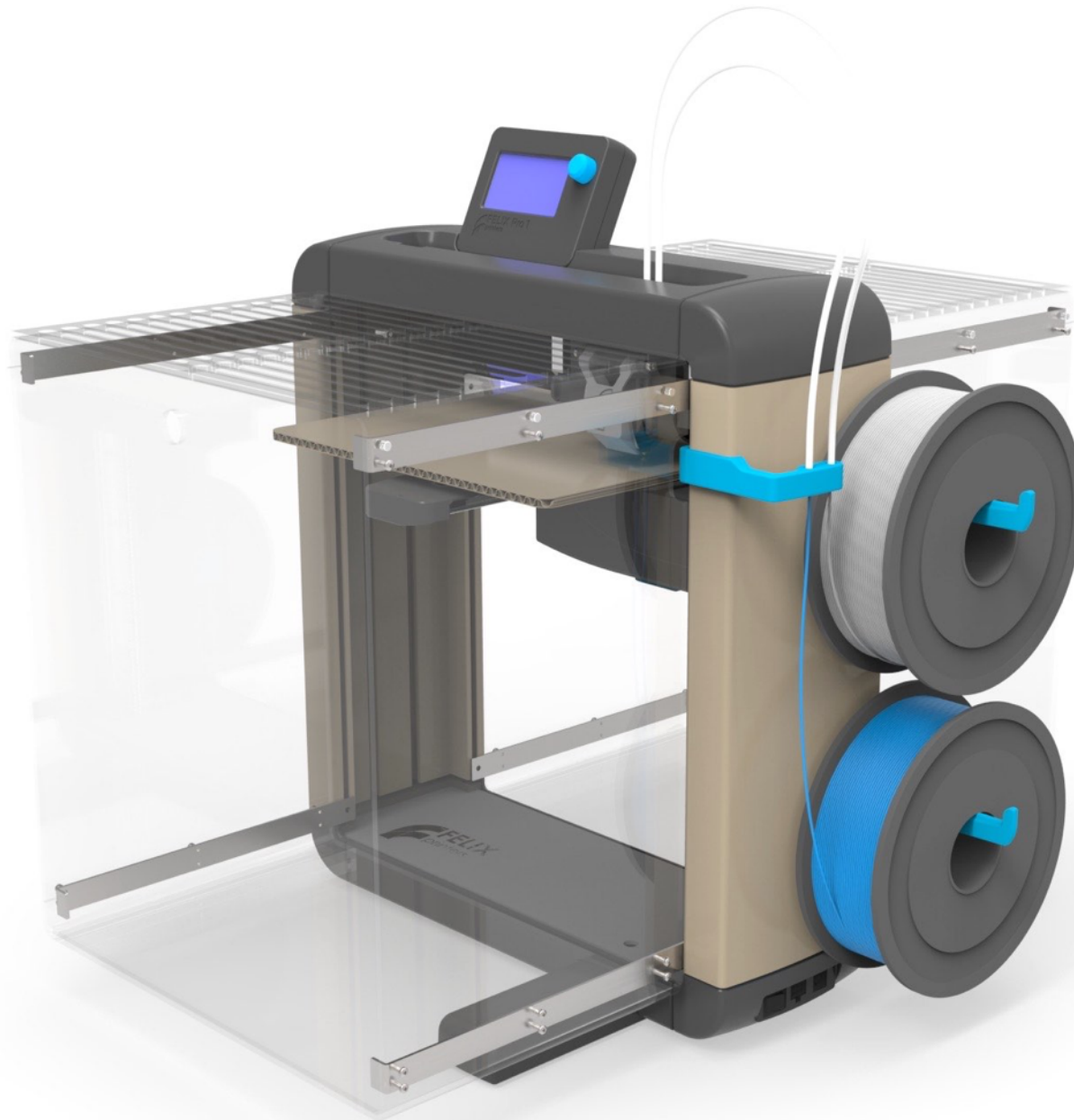

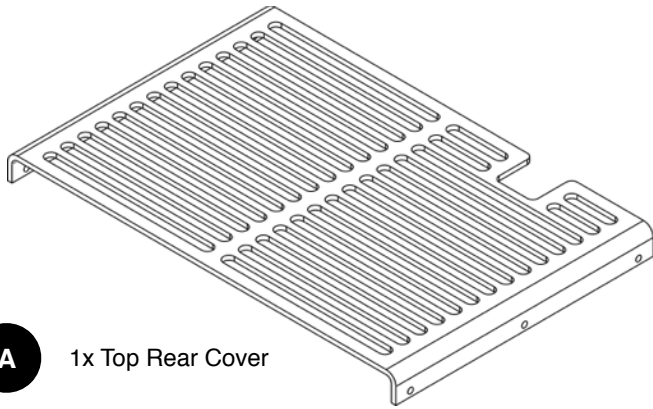

A 1x Top Rear Cover

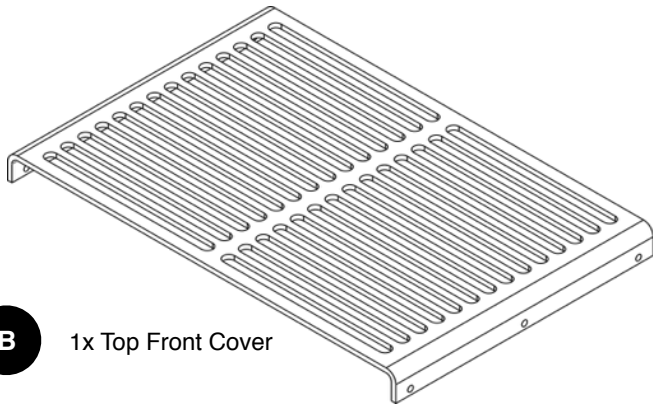

B 1x Top Front Cover

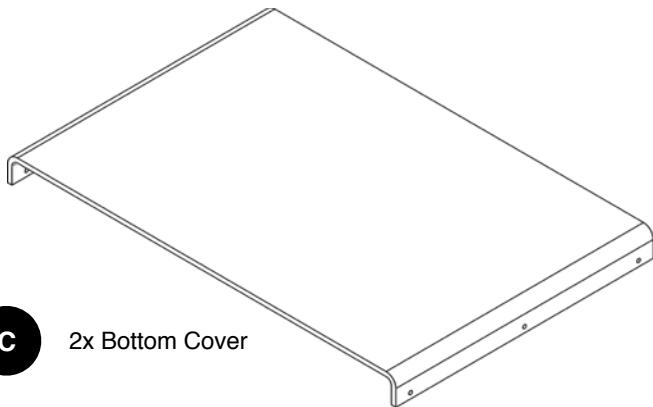

C 2x Bottom Cover

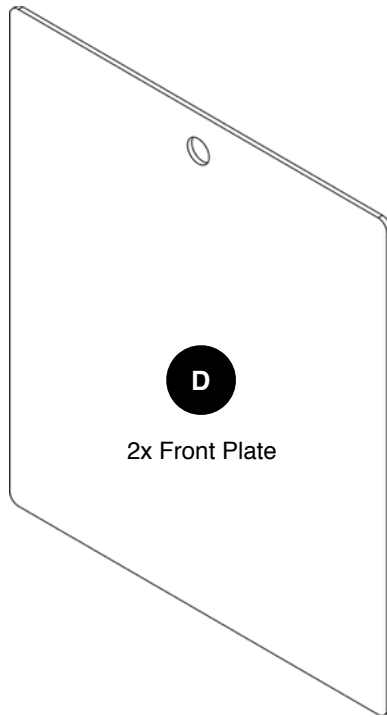

D 2x Front Plate

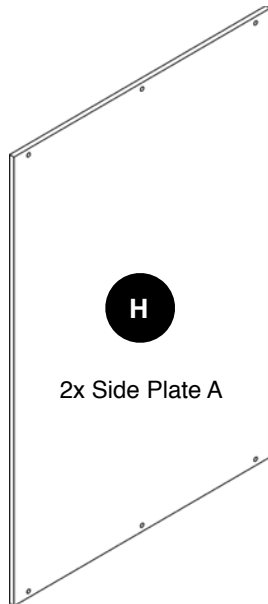

H 2x Side Plate A

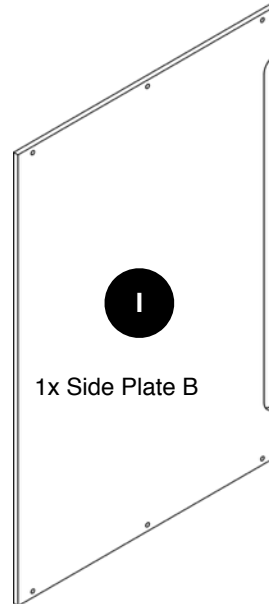

I 1x Side Plate B

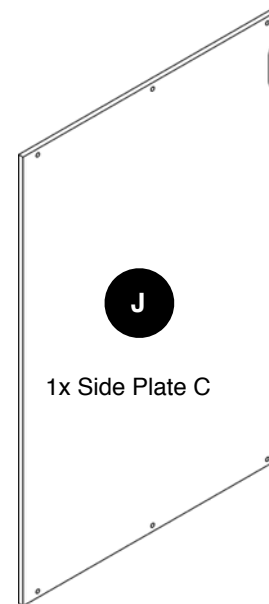

J 1x Side Plate C



E 36x Bolt M3 x 6



F 4x T-Nut



G 4x Bolt M4 x 12

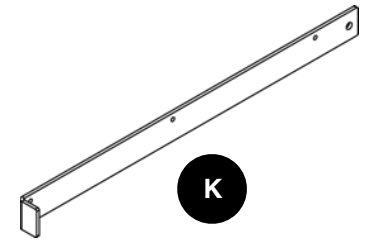

K 1x Front Right Bracket

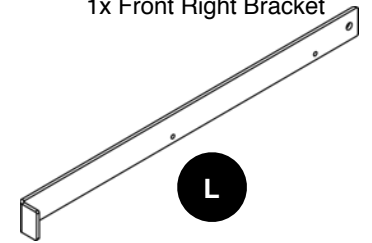

L 1x Front Left Bracket

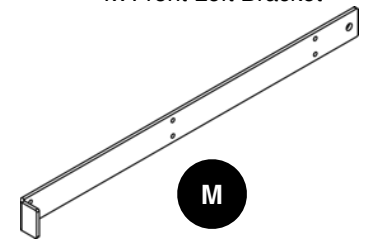

M 4x Bottom Bracket

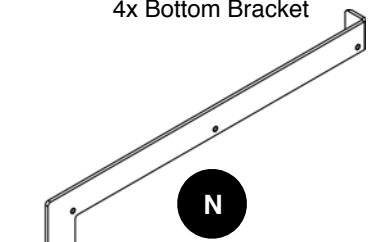

N 1x Rear Right Bracket

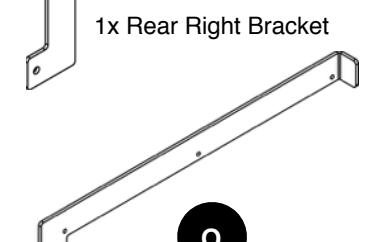

O 1x Rear Left Bracket

1

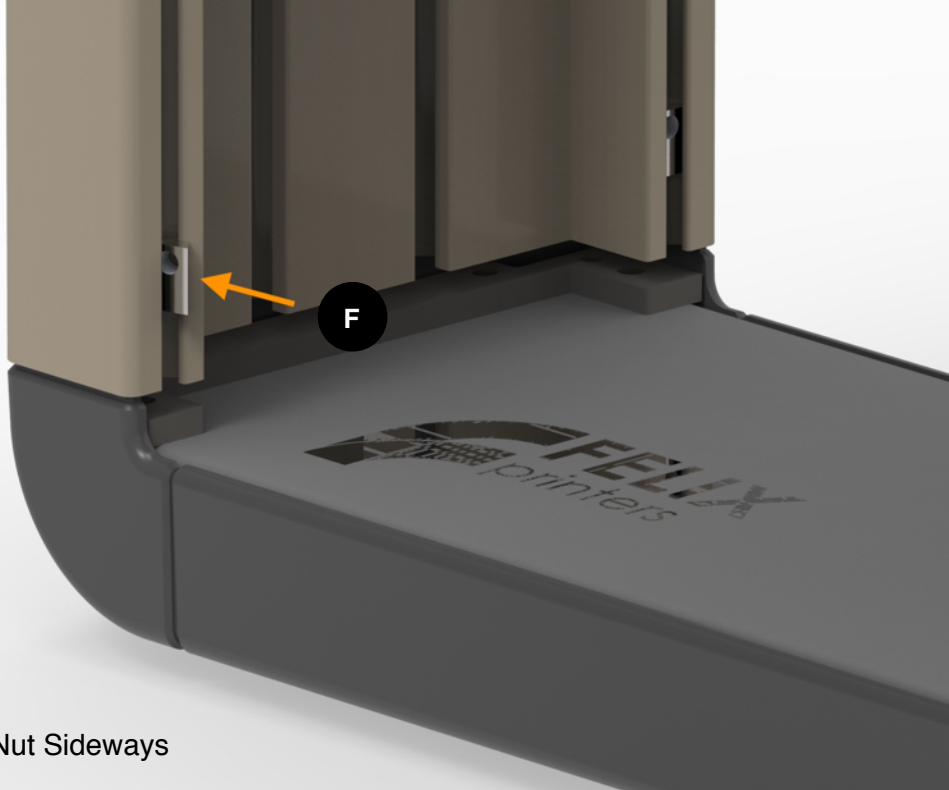

Push in T-Nut Sideways

2

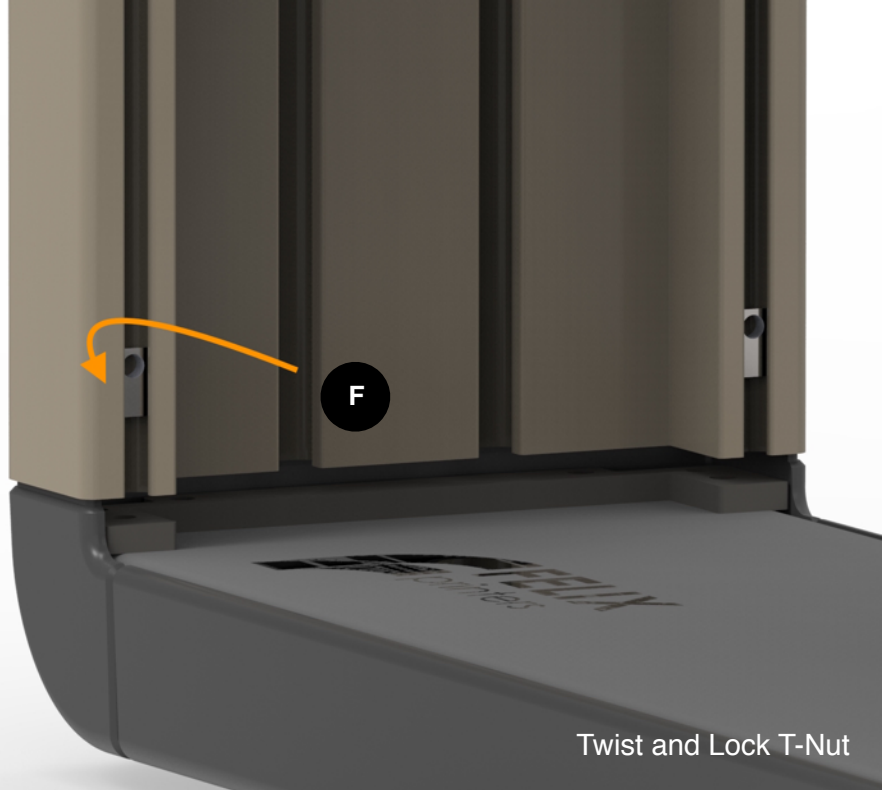

Twist and Lock T-Nut

3

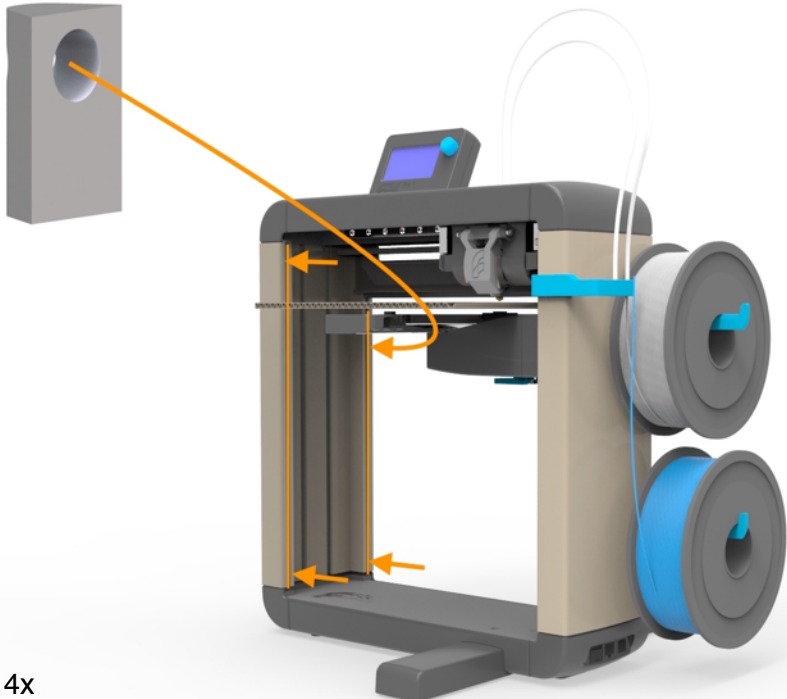

Left - Repeat 4x

4

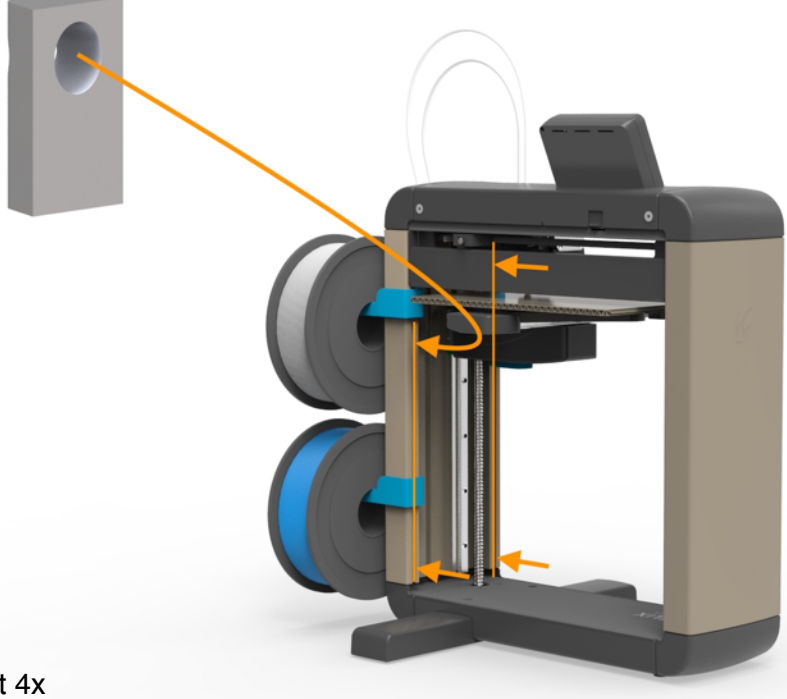

Right - Repeat 4x

5

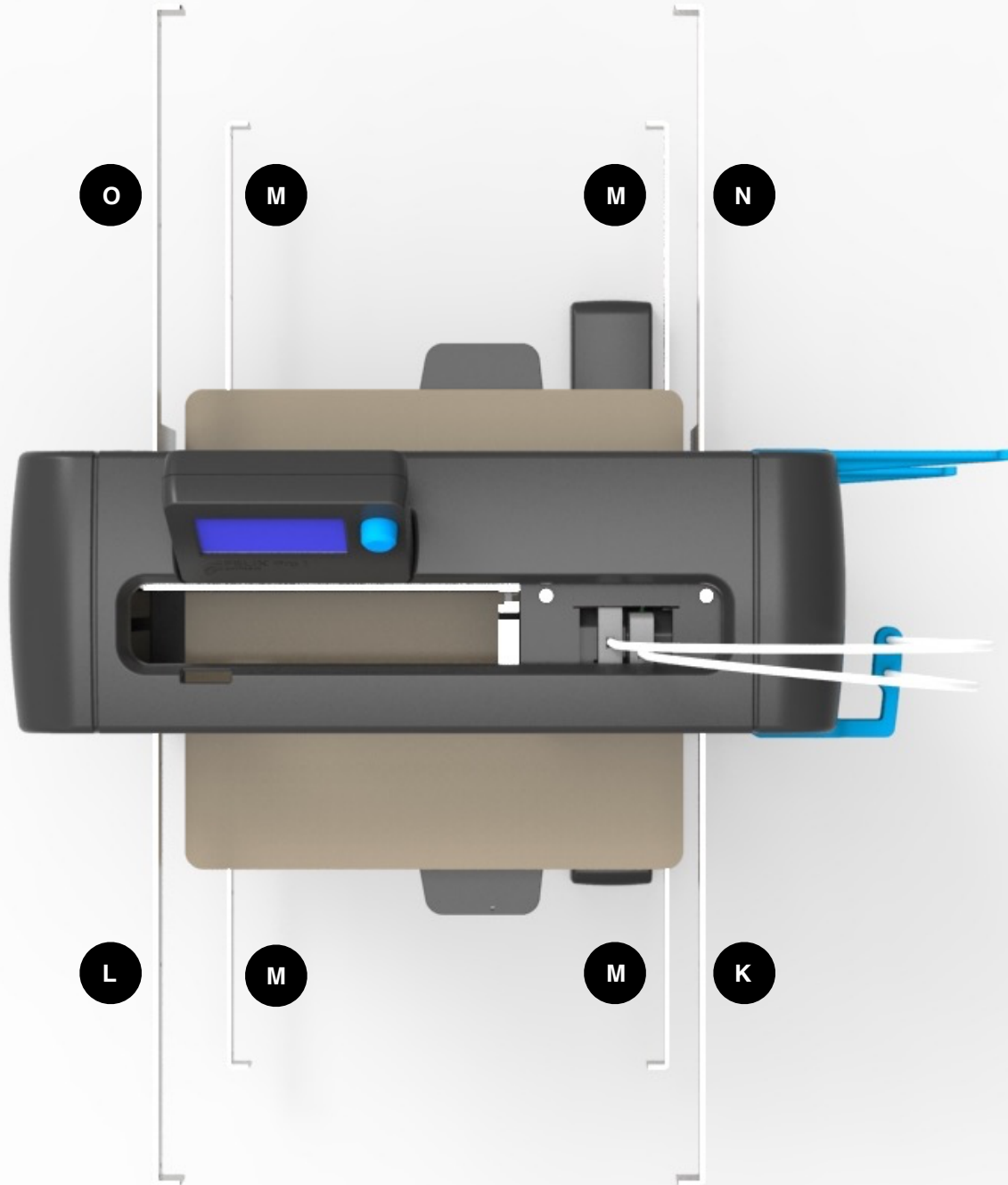

6

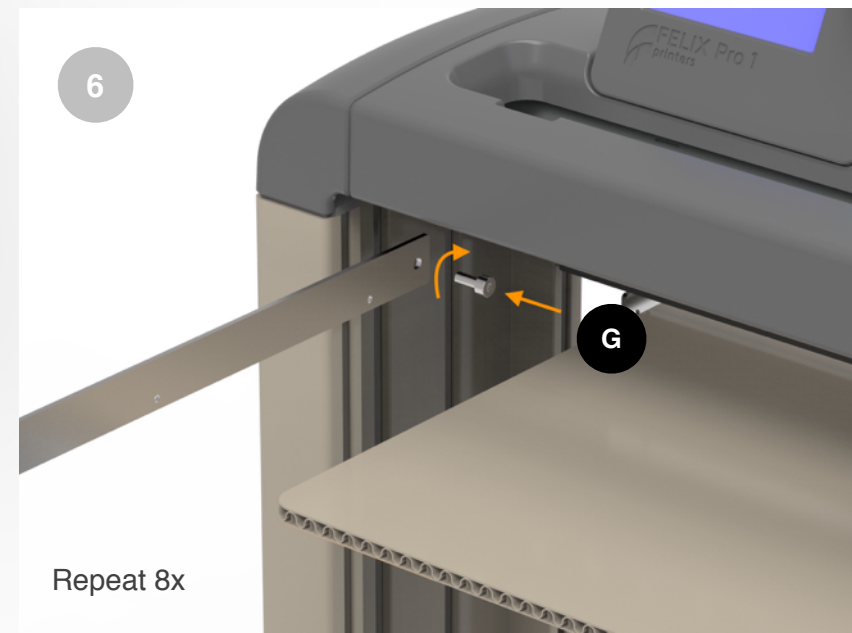

Repeat 8x

